

ELEV8² TOUCH

SIT-STAND DESKING

The ability to sit and stand during the average working day has huge health benefits to the user, helping to burn calories, boost energy levels, improve posture and promote mental well-being. In addition to the numerous health benefits provided by periodic standing, studies show that Elev8² height adjustable desks promote creativity, team interaction, collaboration, and the willingness to share ideas.

The Elev8² Touch desking range provides the ideal solution to address the issue of employees who have a sedentary desk job and who do not spend enough time standing during the working day. Sit-stand desks create an environment where colleagues can collaborate at standing meetings before adjusting their desk back to a seated height to continue with their routine tasks.

STYLES

STRAIGHT



RETURN DESK

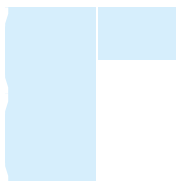

BACK-TO-BACK

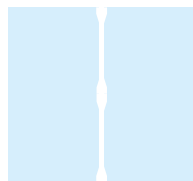



ELEV8² TOUCH Sit-Stand desking



Finish Options

Table tops available in Beech, Oak, Walnut, White and White with Oak trim. Frames available in Black, Silver and White

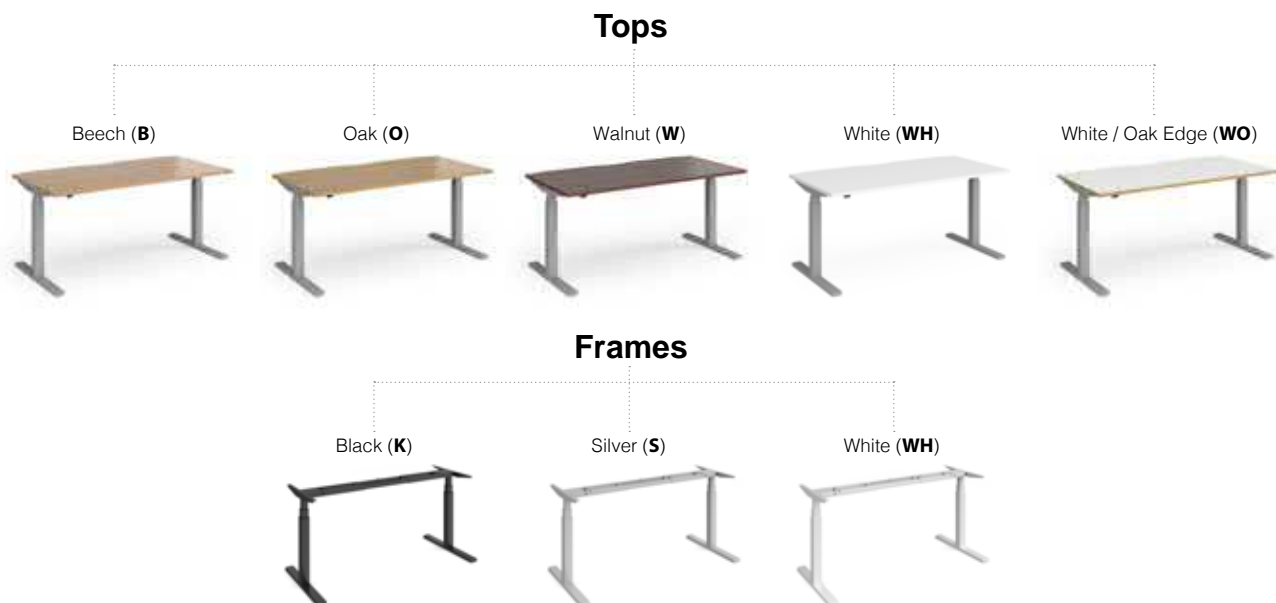

Details & Features



Double Motor

Sit-stand desk height adjustment is made through a twin motor for fast, fluid and natural movement of the 25mm desktops with a maximum weight loading of 160kg



Three Part Frame

The three tiered leg column offers adjustability from 675mm to 1300mm with a low noise level of 39db to provide all the health benefits of periodic standing



Fabric Screens

Vibe desktop screens are available in special sizes for Elev8² which provide the same level of privacy between back-to-back Elev8² desks when at their highest and lowest points



Cable Management

Energy cable chain fits inside the lower cable channel of back-to-back desks for cable management with a vertical cable spine option for the single desks to carry wires from floor to desktop

Elev8² Touch - Sit-stand Single Desks & Accessories

Single Desks

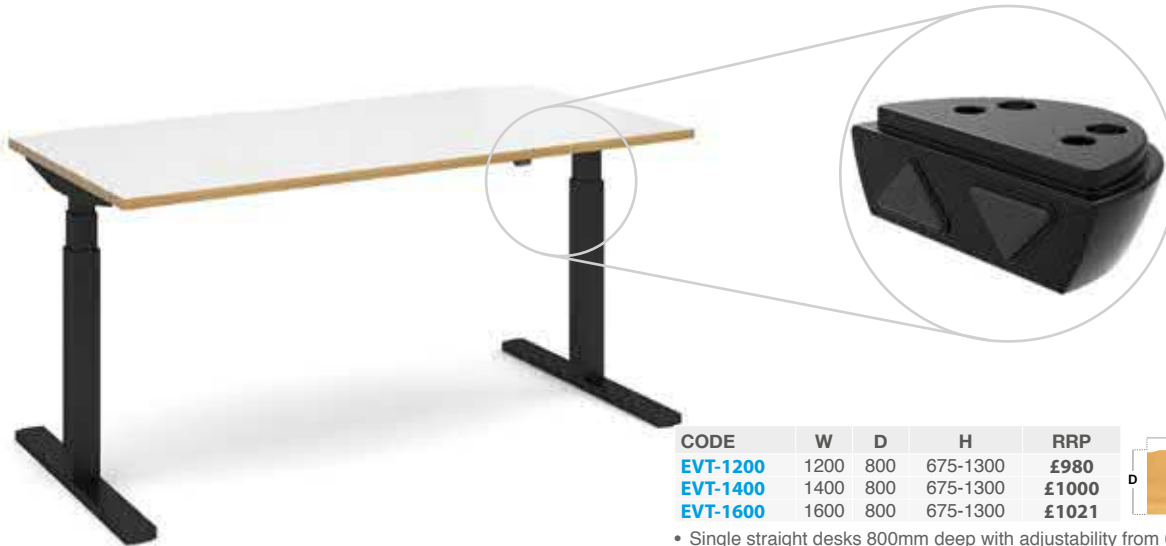

CODE	W	D	H	RRP
EVT-1200	1200	800	675-1300	£980
EVT-1400	1400	800	675-1300	£1000
EVT-1600	1600	800	675-1300	£1021

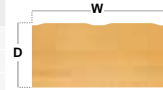

- Single straight desks 800mm deep with adjustability from 675mm-1300mm
- Powerful twin motors raise and lower the desktop at a 39db noise level

Vibe Elev8² Screens for Single Desks



CODE	W	D	H	Band A	Band B	Band C
EV1000	1000	25	600	£169	£181	£203
EV1200	1200	25	600	£192	£203	£224
EV1400	1400	25	600	£214	£224	£247
EV1600	1600	25	600	£237	£247	£269



Made to Order
Bands A, B & C

- Made to order designer office screens supplied with fitting brackets
- 25mm thick screens which are 600mm high specifically for Elev8² single desks

Upper Cable Channel

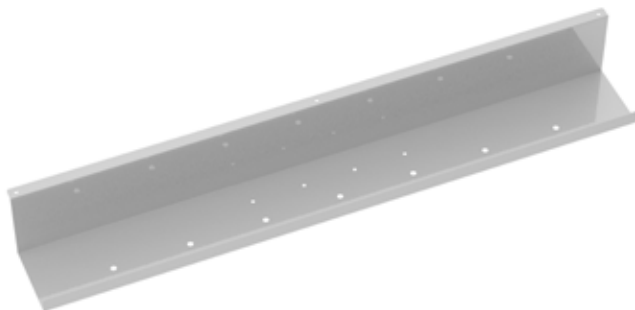

CODE	W	D	H	RRP
EV-UCC	800	100	100	£41

- Cable management tray to use on single straight desks
- Positioned under the Elev8² desk so cables are out of the way

Vertical Cable Spiral



CODE	W	D	H	RRP
EV-SN	80	80	150-1300	£67

- Simple attractive solution which extends to carry cables from floor to desktop
- Spring like expansion from 150mm-1300mm working length

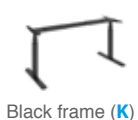

Black frame (**K**)

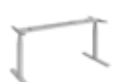

Silver frame (**S**)



White frame (**WH**)



Beech (**B**)



Oak (**O**)



Walnut (**W**)



White (**WH**)



White / Oak Edge (**WO**)

Please add frame finish followed by desktop colour when ordering eg. **EVT-1600** with Black frame in White/Oak = **EVT-1600-K-WO**

Elev8² Touch - Sit-stand Return Desks

Return Desk



CODE	W	D	H	RRP
EVTR-RET	800	600	675-1300	£715



- Sits on either side of the sit-stand straight desks to increase the working area
- The two base columns of the straight and return desk stay perfectly synched

Single Desk with Return



CODE	W	D	H	w	d	RRP
EVTR-1400	1400	800	675-1300	600	1600	£1715
EVTR-1600	1600	800	675-1300	600	1600	£1736



- Rectangular desks 800mm deep complete with 800mm return desk
- Return can be fitted to either side of desk to extend the sit-stand working area

Digital Control Box



CODE	W	D	H	RRP
TDH5-P	105	40	20	£79

- Allows for 4 different stored height settings
- Can be fitted to all Elev8² Touch desking



Black frame (**K**)

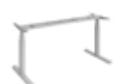

Silver frame (**S**)

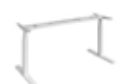

White frame (**WH**)



Beech (**B**)



Oak (**O**)



Walnut (**W**)



White (**WH**)



White / Oak Edge (**WO**)

Please add frame finish followed by desktop colour when ordering eg. **EVTR-1600** with Black frame in White/Oak = **EVTR-1600-K-WO**

Elev8² Touch - Sit-stand Back-to-back Desks & Accessories

Back-to-Back Desks



CODE	W	D	H	RRP
EVTB-1200	1200	1650	675-1300	£2041
EVTB-1400	1400	1650	675-1300	£2092
EVTB-1600	1600	1650	675-1300	£2143

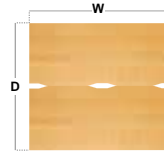

- Two straight 800mm deep desks back-to-back with adjustability from 675mm-1300mm
- Powerful twin motors raise and lower the back-to-back desks independently

Vibe Elev8² 600mm High Screens for Back-to-Back Desks

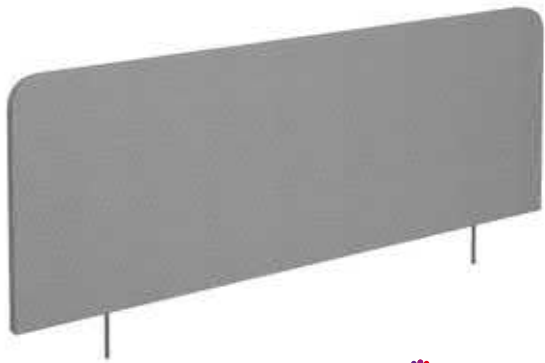

CODE	W	D	H	Band A	Band B	Band C	Band D	Band E
EVSS-1200	1200	25	600	£198	£209	£220	£242	£270
EVSS-1400	1400	25	600	£254	£264	£275	£308	£360
EVSS-1600	1600	25	600	£281	£303	£324	£363	£438

- Made to order designer office screens 600mm high
- 25mm thick screens specifically designed for Elev8² Touch back-to-back desks

Vibe Elev8² Curved Screens for Back-to-Back Desks

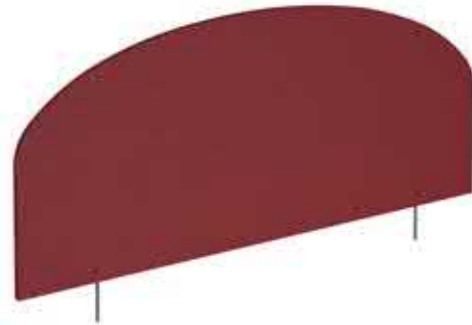

CODE	W	D	H	Band A	Band B	Band C	Band D	Band E
EVSC-1200	1200	25	400/700	£220	£232	£242	£264	£292
EVSC-1400	1400	25	400/700	£275	£286	£297	£330	£382
EVSC-1600	1600	25	400/700	£303	£324	£346	£385	£460

- Made to order designer office screens 700mm high at central point
- 25mm thick screens specifically designed for Elev8² Touch back-to-back desks

Lower Cable Channel for Back-to-Back Desks

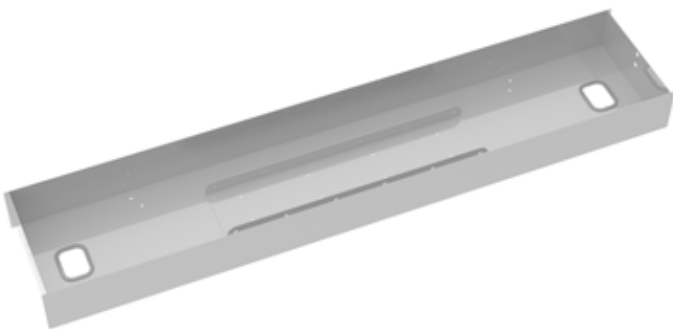

CODE	W	D	H	RRP
EV-LCC-854	1028	250	100	£103
EV-LCC-1054	1228	250	100	£133
EV-LCC-1254	1428	250	100	£164

- Shared cable tray with cover which sits central to two back-to-back Elev8² desks
- Supplied with lid and cable runs between the tray for cable management

Vertical Cable Chain



CODE	W	D	H	RRP
EV-CHAIN-K	52	25	1000	£77

- Fits inside the lower cable channel of back-to-back desks for cable management
- Easy to fit and available in black only



Black frame (**K**)



Silver frame (**S**)

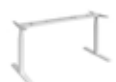

White frame (**WH**)



Beech (**B**)



Oak (**O**)



Walnut (**W**)



White (**WH**)



White / Oak Edge (**WO**)

Please add frame finish followed by desktop colour when ordering eg. **EVTB-1600** with Black frame in White/Oak = **EVTB-1600-K-WO**



Elev8² Touch - Bluetooth Control Unit

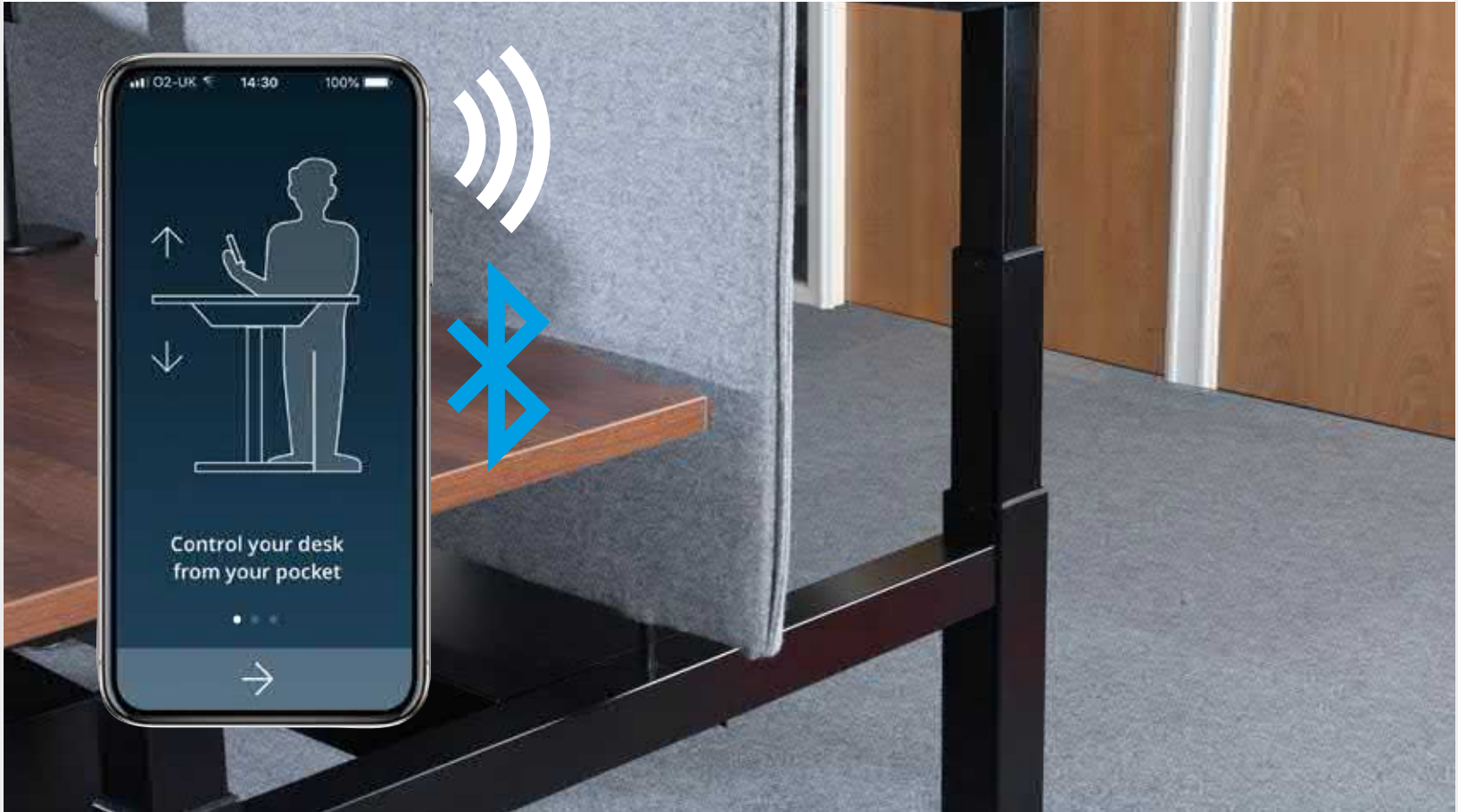

Bluetooth Control Unit

Having the option to stand, as well as sit during the work day has been proven not only to benefit the health of the user but also of the business, dramatically improving health, well-being and energy levels of employees. However just simply having a height adjustable desk is not always enough to make some employees vary their posture throughout the working day. The app has been developed to remind you when it is time to change postures and help you achieve activity goals.

CODE	RRP
EVT-BCU	£70

- Memory function to set your own height preference settings
- Customised sit-stand cycle to remind you to stand up at the right time
- Tracks all the time you've stood
- Calculates calories burned during your standing
- Safety support with error alarm notices



Simply insert the dongle into the control box and fit to your existing Elev8² Touch sit-stand desk, download the free app and then pair the app with any connected Elev8² Touch desk to take charge of your work experiences. The height adjustable desk can then be adjusted via a smartphone or tablet.



Get the most out of your height adjustable desk by reminding you to vary your position during the day, with the ability to control the height of your desk as well as memory settings for everyday use.

Elev8² Touch - Battery Pack



Battery Pack

With the Elev8² battery pack you can enjoy the smooth, fast, electrically powered height adjustable features of an Elev8² desk, without the need for any power leads. Perfect for accommodating sit-stand desks in locations where getting access to a wall plug may not be convenient, this battery pack discreetly mounts to the underside of Elev8² Touch desks and works for up to 4 weeks on a single charge.

CODE	W	D	H	RRP
EVT-BPK	215	85	35	£350

- Easy detachable battery pack which can be charged with a standard USB
- LED indicator and buzzer for battery capacity status
- Rechargeable battery that provides mobility to office furniture
- Slim and easy mounting dock, perfect for desk applications



A LED light and buzzer lets you know when you're low on power, and a recharge only takes a few hours. The Elev8² battery pack is perfect for people who like the idea of saving energy and going off the grid, at home or in the office.