

# Technical

description

Available from - Merlin Industrial Products Ltd - 0800 0418 650 - [info@merlin-industrial.co.uk](mailto:info@merlin-industrial.co.uk)

# Technical description

## 1. Desks with slab-end legs

### 1.1. Table top

**Fixed table tops** – total thickness 85 mm, consist of two parts:

- carcass – made of lacquered medium density fibreboard, thickness 19 mm and 35 mm, carcass depth 72 mm,
- top part – made of chipboard, thickness 12 mm, covered with veneer with 1 mm natural edge.

Both parts are linked with press-fit dowel connectors ensuring quick disassembly and re-assembly.

Available shapes of the tops: rectangle (corners rounded with a radius of 50 mm). Cut outs for metal cable outlets as well as media ports in various types and configurations applicable as an option.

**Inserted pads** for table tops – applicable as an option:

- leather pad – dimensions 996 × 496 mm with edges rounded at 46 mm radius, covered with black SD leather.

- glass pad – made of hardened lacquered glass, thickness 4 mm, with edges rounded at 15 mm radius. Pad width depends on table top width, depth 280 mm. Applicable to rectangular table tops only.

- leather and glass pads – simultaneous use of both pads, applicable to rectangular table tops only.

**Drawer** for table tops – made of lacquered medium density fibreboard, internal part upholstered with black SD leather, applicable as an option. Integrated with table top carcass, consisting of two internal drawers 350 × 250 × 40 mm connected with one front, width 915 mm, equipped with push-to-open system. Applicable to rectangular and back-rounded table tops.

**Frame** – made of steel profiles 50 × 25 mm and 50 × 50 mm (crossbeams), placed inside table top carcass.

### 1.2. Base

**Slab-end legs** – total thickness 85 mm, consist of two parts:

- carcass – made of lacquered medium density fibreboard, thickness 19 mm and 35 mm, carcass depth 72 mm,
- top part – made of chipboard, thickness 12 mm, covered with veneer with 1 mm natural edge.

Both parts are linked with press-fit dowel connectors ensuring quick disassembly and re-assembly.

Legs edges rounded at 50 mm radius.

**Frame** – made of steel profiles 50 × 25 mm, 50 × 50 mm and steel tube Ø 30 mm, placed inside leg carcass.

Fixed height 750 mm as standard, levelling in range of 10 mm.

Desk assembly is by connecting table top and legs frames. Desk construction allows for cable management inside table top and legs carcasses. Bottom part of legs is ended with cut outs providing access to power supply.

### 1.3. Product range

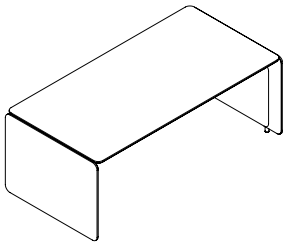

Rectangular desk

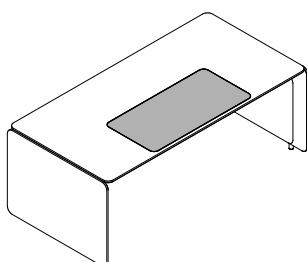
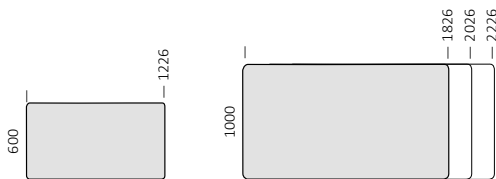

Inserted leather pad

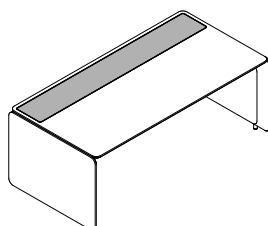

Inserted glass pad

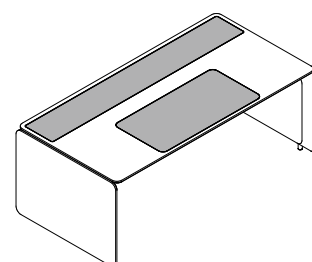

Inserted leather and glass pads

Available from - Merlin Industrial Products Ltd - 0800 0418 650 - [info@merlin-industrial.co.uk](mailto:info@merlin-industrial.co.uk)

## 1.4. Sample order

Product code										Finish code					
Product line	Table top shape	Inserted pads	Dimensions		Cut out type	Cut out position	Base type	Drawer			Top part of table top and legs	Carcass of table top and legs	Leather inserted pad	Glass inserted pad	0
WNR	R	X	2	7	P	L	4	C	N	—	DM	FI	S1	SI	00

The following part of code **WNRX27PL4CN-DMFIS1SI00** identifies product as:

eRange (**WNR**) rectangular desk (**R**), table top with inserted leather and glass pads (**X**), dimensions 1826 × 1000 mm (**27**), left cut out for rectangular metal cable outlet with brush 160 × 80 mm – included (**PL**), slab-end legs (**4**), table top with integrated drawer (**C**)

The following part of code **WNRX27PL4CN-DMFIS1SI00** identifies product finishes as:

Top part of table top and legs veneered in natural oak colour (**DM**), carcass of table top and legs in white laquered MDF (**FI**), inserted pad in black SD leather (**S1**), inserted lacquered glass pad in white colour (**SI**)

## 2. Desks with electric height adjustment

### 2.1. Table top

**Fixed table tops** – total thickness 41 mm, consist of two parts:

- carcass – made of lacquered medium density fibreboard, thickness 19 mm and 35 mm, carcass depth 28 mm,
- top part – made of chipboard, thickness 12 mm, covered with veneer with 1 mm natural edge.

Both parts are linked with press-fit dowel connectors ensuring quick disassembly and re-assembly.

Table tops available in rectangular shape with edges rounded at 50 mm radius. Cut outs for grommets as well as media ports in various types and configurations applicable as an option.

**Inserted pads** for table tops – applicable as an option:

- leather pad – dimensions 996 × 496 mm with

edges rounded at 46 mm radius, covered with black SD leather.

### 2.2. Base

**T-legs with electric height adjustment** –

three-segment columns made of steel tubes – Ø 70 mm, Ø 63 mm, Ø 56 mm, from bottom to top respectively, with feet equipped with leveling glides. Each column is equipped with a drive placed inside, for telescoping function, connected with control box with following plug standards: European (EU), British (GB) and Swiss (CH).

**Control panel** for height adjustment with display and memory function, as standard.

**Anti-Collision function** – columns automatically detects obstacles, which helps to avoid collision, as standard.

**Foot** – with rounded ends, equipped with plastic glides, levelling in range of 10 mm.

**Frame** – consists of metal beam made of steel profile 100 × 40 mm, and two supporting beams made of steel profile 30 × 40 mm. Frame pre-assembled to table top carcass.

**Finish options:** powder-coated in black or white colour.

Desk includes horizontal, foldable wire trunking as standard, with dedicated width, powder-coated in black or white colour.

**Note:** when selecting particular base colour (i.e. black), the same colour applies to following elements: table top carcass, horizontal wire trunking and metal grommet.

### 2.3. Product range

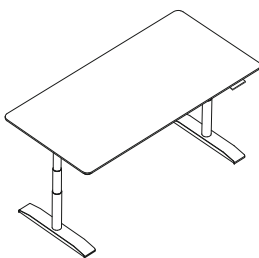

# Technical description

## 3. Desks with slab-end leg for integration with sideboard

**3.1. Table top and leg** – structure is the same as in free-standing desks with slab-end legs. Contrary to free-standing desk it consists of one slab-end leg and dedicated connector for sideboard integration. Connector is made of

metal structure, placed inside casing made of lacquered medium density fibreboard, thickness 19 mm. Casing dimensions 700 × 170 mm, height 88 mm with rounded corners at 50 mm radius.

### 3.2. Product range

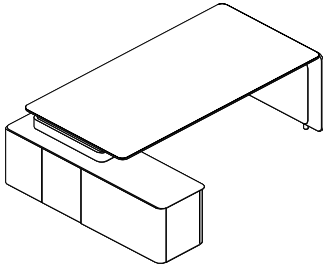

Desk with rectangular table top  
For integration with sideboard (left version)

## 4. Sideboards for integration with desk

### 4.1. Sideboard versions:

- 4 hinged doors,
- 3 hinged doors, pencil tray (upholstered in black SD leather) and 3 drawers,
- 4 hinged doors, pencil tray (upholstered in black SD leather) and 3 drawers.

All sideboard versions are double-sided with rounded corners at 50 mm radius.

Sideboard base, angled at 45° – made of lacquered medium density fibreboard, thickness 19 mm, with metal beams inside.

Base height 38 mm, equipped with levelling glides.

### Finish options:

#### Veneer

- front, sides, back, dividing wall and shelves – made of chipboard, thickness 18 mm, covered with veneer with natural edge,
- bottom part, upper part and top – made of chipboard, thickness 12 mm, covered with veneer with natural edge,
- internal part of drawers (if applicable) – made of melamine faced chipboard (MFC), thickness 12 mm in slate colour (MS) only.

#### Veneer / melamine faced chipboard (MFC)

- top – made of chipboard, thickness 12 mm, covered with veneer with natural edge,

- front, sides, back, dividing wall – made of chipboard, thickness 18 mm, covered with veneer with natural edge,
- bottom part, upper part, internal part of drawers (if applicable) – made of melamine faced chipboard (MFC), thickness 12 mm in slate colour (MS) only,
- shelves – made of melamine faced chipboard (MFC), thickness 18 mm in slate colour (MS) only.

All sideboards are fully assembled as standard.

### 4.2. Product range

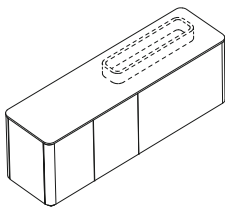

Sideboard for integration with desk  
4 hinged doors

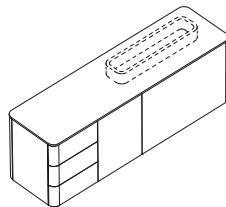

Sideboard for integration with desk  
3 hinged doors, pencil tray and 3 drawers

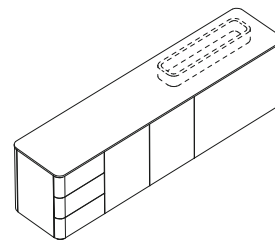

Sideboard for integration with desk  
4 hinged doors, pencil tray and 3 drawers

Available from - Merlin Industrial Products Ltd - 0800 0418 650 - [info@merlin-industrial.co.uk](mailto:info@merlin-industrial.co.uk)

## 5. Conference tables

### 5.1. Table top

**Fixed table tops** – total thickness 85 mm, consist of two parts:

- carcass – made of lacquered medium density fibreboard, thickness 19 mm and 35 mm, carcass depth 72 mm,
- top part – made of chipboard, thickness 12 mm, covered with veneer with 1 mm natural edge.

Both parts are linked with press-fit dowel connectors ensuring quick disassembly and re-assembly.

Table tops available in rectangular shape with edges rounded at 50 mm radius, except for

internal modules without rounded edges. Cut outs for media ports in various types and configurations applicable as an option.

**Frame** – made of steel profiles 50 × 25 mm and 40 × 25 mm (crossbeams), placed inside table top carcass.

### 5.2. Base

**Column leg** – made of metal structure, placed inside casing made of lacquered medium density fibreboard, thickness 19 mm. Casing dimensions 600 × 150 mm (for free-standing table) and 800 × 150 mm (for modular tables), height 655 mm with rounded corners at 50 mm radius.

Fixed height 750 mm as standard, levelling in range of 10 mm.

Conference table assembly is by connecting table top frame with leg metal structure. Table construction allows for cable management inside table tops and legs casings.

### Conference tables versions:

- free-standing,
- modular (internal and external modules).

### 5.3. Product range

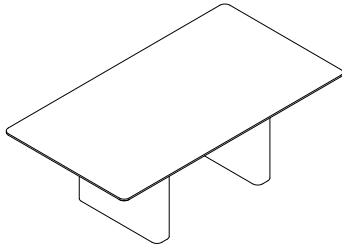

Free-standing table  
2200 × 1200 mm

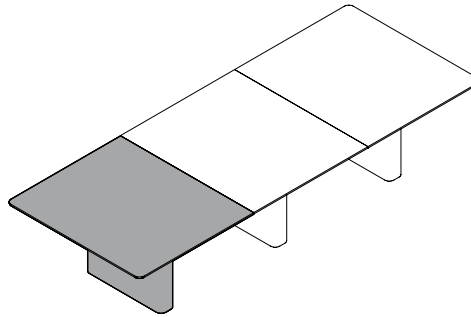

Modular table – external unit  
1200 × 1400 mm

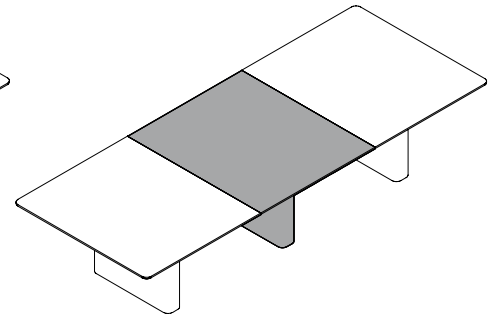

Modular table – internal unit  
1200 × 1400 mm

	Height adjustment		
	Desks		Conference tables
	Slab-end legs	T-legs	Column legs
Fixed height	750 mm	—	750 mm
Electric height adjustment	—	680–1290 mm	—

### Technical parameters (applicable to base with electric height adjustment):

- Anti-Collision technology,
- protection against overheating,
- smooth start&stop,
- smooth up&down movement,
- speed 50 mm / s,
- noise < 50 dB,
- power consumption in standby mode < 0.6 W,
- load capacity 40 kg per table top / two columns,
- direct current drive power supply.

# Technical description

## 6. Panels

### 6.1. Desk panels

Modesty front, for slab-end legs – made of chipboard, thickness 18 mm, covered with veneer with natural edge, with edges rounded at 50 mm radius. Metal brackets powder-coated in alu colour. Applicable to free-standing desks and desks for integration with sideboard, with dedicated dimensions for both versions.

Modesty front, for T-legs – made of chipboard, thickness 18 mm, covered with veneer with natural edge, with edges rounded at 50 mm radius. Metal brackets powder-coated in black or white colour.

### 6.2. Product range

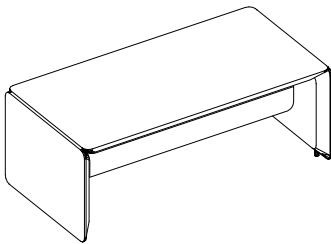

Modesty front for slab-end legs  
For table top width 1800, 2000, 2200 mm

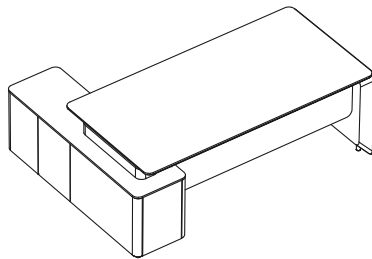

Modesty front for slab-end legs with sideboard  
For table top width 2000, 2200 mm

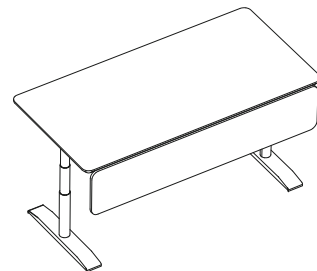

Modesty front for T-legs  
For table top width 1800, 2000 mm

## 7. Pedestals

### 7.1. Mobile

3 drawers and pencil tray inside (upholstered in black SD leather).

Pedestal has rounded corners at 50 mm radius, it is equipped with push-to-open system, locks available as an option.

Pedestal base, angled at 45° – made of lacquered medium density fibreboard, thickness 19 mm. Base height 38 mm, with four Ø 50 mm castors, two equipped with brakes.

#### Finish options:

- top – made of chipboard, thickness 12 mm, covered with veneer with natural edge,
- front, sides and back – made of chipboard,

thickness 18 mm, covered with veneer with natural edge,  
– bottom part, upper part, internal part of drawers – made of melamine faced chipboard (MFC), thickness 12 mm in slate colour (MS) only.

Pedestal are fully assembled as standard.

### 7.2. Product range

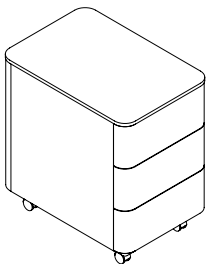

Mobile  
3 drawers and pencil tray inside

Available from - Merlin Industrial Products Ltd - 0800 0418 650 - [info@merlin-industrial.co.uk](mailto:info@merlin-industrial.co.uk)

## 8. Cabinets

### 8.1. Cabinets versions

#### Modular:

- hinged door (external and internal modules),
- glass door (internal module).

**Hinged door** – free-standing and external modules have door corners both-sides or one-side rounded at 50 mm radius, depending on selected version. In internal modules door corners are not rounded. Cabinets are equipped with push-to-open system, locks available as an option.

**Glass door** – available as internal modules only, door corners are not rounded. Doors made of lacquered hardened glass, thickness 6 mm, equipped with push-to-open system, without locks.

Cabinets are not equipped with top as standard, tops for free-standing cabinets as well as modular cabinets arrangements to be ordered separately. Arrangement of cabinets must be of the same height and external hinged door cabinets are to be put as last in configuration. **Cabinet base**, angled at 45° – made of lacquered medium density fibreboard, thickness 19 mm. Base height 38 mm, equipped with levelling glides.

#### Finish options:

##### Veneer

- front (if applicable), sides, and shelves – made of chipboard, thickness 18 mm, covered with veneer with natural edge,

- bottom part, upper part and back – made of chipboard, thickness 12 mm, covered with veneer with natural edge.

##### Veneer / melamine faced chipboard (MFC)

- front (if applicable) and sides – made of chipboard, thickness 18 mm, covered with veneer with natural edge,
- back, bottom part and upper part – made of melamine faced chipboard (MFC), thickness 12 mm in slate colour (MS) only,
- shelves – made of melamine faced chipboard (MFC), thickness 18 mm in slate colour (MS) only.

All cabinets are fully assembled as standard, except for cabinet top.

### 8.2. Product range

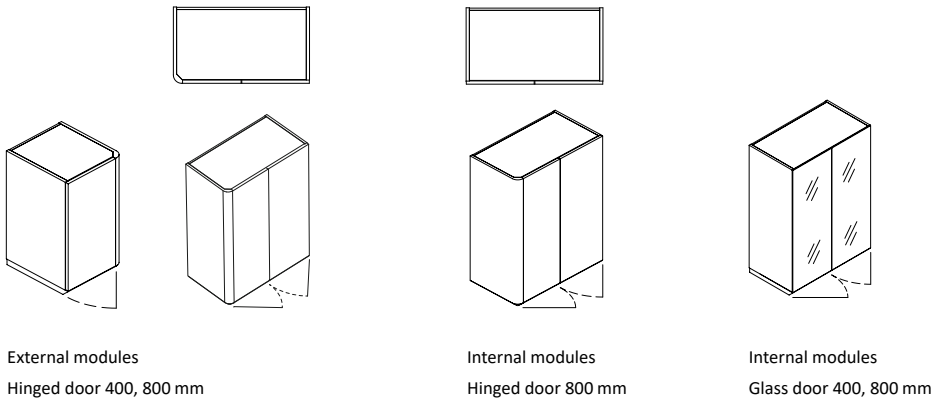

External modules

Hinged door 400, 800 mm

Internal modules

Hinged door 800 mm

Internal modules

Glass door 400, 800 mm

### Example of cabinets arrangement

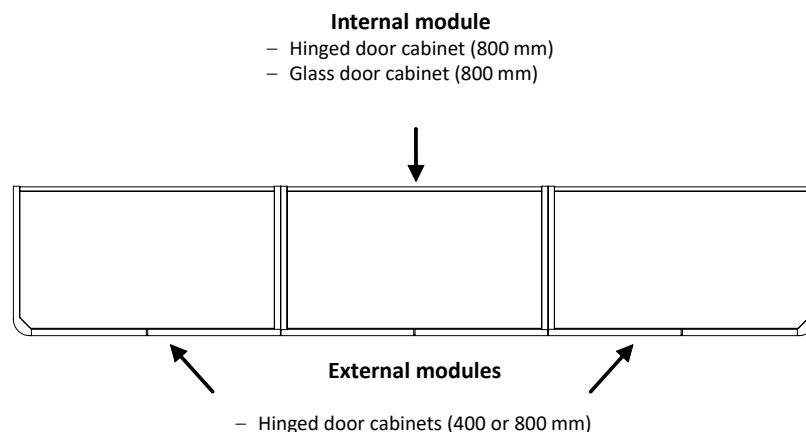

Maximum width of cabinets arrangement linked with one cabinet top is 2400 mm

# Technical description

## 8.3. Sample order

Product code										Finish code					
Product line	Model		Dimensions			Version			Assembly		Back	Base	Side	Front	Upper, bottom part and shelves
WNR	S	G	0	8	3	S	L	N	Z	—	DM	FS	DM	SS	DM

The following part of code **WNRSG043SLNZ-DMFSDMSSDM** identifies product as:  
eRange (**WNR**) cabinet with glass door (**SG**), width 800 mm (**08**), height 3 OH (**3**), left internal module (**SL**), fully assembled (**Z**)

The following part of code **WNRSG083SLNZ-DMFSDMSSDM** identifies product finishes as:  
Back veneered in natural oak colour (**DM**), cabinet base in grey laquered MDF (**FS**), sides veneered in natural oak colour (**DM**), lacquered glass door in grey colour (**SS**), upper part, bottom part and shelves veneered in natural oak colour (**DM**)

## 9. Mobile sideboards

### 9.1. Sideboard versions:

- 2 hinged doors and 2 drawers (1 with filing frame),
- 2 hinged doors and 3 drawers.

All sideboard versions have rounded corners at 50 mm radius, they are equipped with push-to-open system, locks available as an option. Rectangular metal cable outlet with brush 160 × 80 mm available as an option. Sideboard base, angled at 45° – made of lacquered medium density fibreboard, thickness 19 mm.

Base height 38 mm, with five castors (for width 1200 mm), two equipped with brakes.

#### Finish options:

#### **Veneer**

- front, sides, back, dividing wall and shelves – made of chipboard, thickness 18 mm, covered with veneer with natural edge,
- bottom part, upper part and top – made of chipboard, thickness 12 mm, covered with veneer with natural edge,
- internal part of drawers (if applicable) – made of melamine faced chipboard (MFC), thickness 12 mm in slate colour (MS) only.

#### **Veneer / melamine faced chipboard (MFC)**

- top – made of chipboard, thickness 12 mm, covered with veneer with natural edge,
- front, sides, back, dividing wall – made of chipboard, thickness 18 mm, covered with veneer with natural edge,
- bottom part, upper part, internal part of drawers (if applicable) – made of melamine faced chipboard (MFC), thickness 12 mm in slate colour (MS) only,
- shelves – made of melamine faced chipboard (MFC), thickness 18 mm in slate colour (MS) only.

All sideboards are fully assembled as standard.

### 9.2. Product range

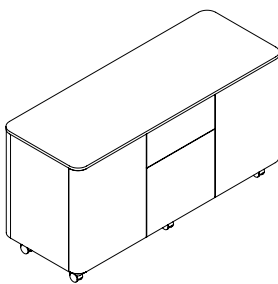

2 hinged doors and 2 drawers (1 with filing frame)  
1200 mm

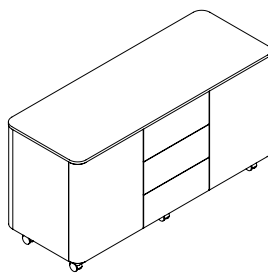

2 hinged doors and 3 drawers  
1200 mm



# Price list

Available from - Merlin Industrial Products Ltd - 0800 0418 650 - [info@merlin-industrial.co.uk](mailto:info@merlin-industrial.co.uk)

# Desks

## Rectangular table top Slab-end legs

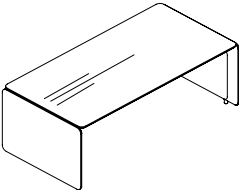

W	N	R	R	N	0	5	N	N	4	N	N	Width [mm]	Depth [mm]	Veneer	Basic price (GBP)
W	N	R	R	N	0	5	N	N	4	N	N	1226	600	Veneer	2863
W	N	R	R	N	2	7	N	N	4	N	N	1826	1000	Lacquered MDF: White (FI), Grey (FS), Black (FG)	4123
W	N	R	R	N	2	8	N	N	4	N	N	2026		N Table top without inserted pads	4216
W	N	R	R	N	2	9	N	N	4	N	N	2226		Basic price (GBP)	4402

Code	Description
N	No cut outs for: cable outlets/media ports
P L	Left
P R	Right
E L	Left
E R	Right
E M	Middle*
N	Table top without drawer
C	Table top with integrated drawer – surcharge 739 GBP
N	Table top without inserted pads
L	Table top with inserted leather pad – leather in: Black (S1) – surcharge 180 GBP
G	Table top with inserted glass pad – glass in: White (SI), Grey (SS), Black (SG) – surcharge 379 GBP
X	Table top with inserted leather and glass pads – leather in: Black (S1), glass in: White (SI), Grey (SS), Black (SG) – surcharge 556 GBP

Rectangular cut out for metal cable outlet with brush 160×80mm (included)

Rectangular cut out for metal cable outlet with brush 240×100mm with access to media port Netbox M 4M (outlet as a part of media port)

All types of media ports to be ordered separately according to availability [matrix](#) and [price list](#)  
\*Not applicable to table top versions with inserted glass pad (G), or with inserted leather and glass pads (X)

Available from - Merlin Industrial Products Ltd - 0800 0418 650 - [info@merlin-industrial.co.uk](mailto:info@merlin-industrial.co.uk)

## Rectangular table top T-legs with electric height adjustment

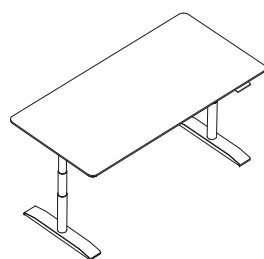

<b>N</b>	<b>N</b>	No cut outs for: grommets/media ports
<b>P</b>	<b>L</b>	Left
<b>P</b>	<b>R</b>	Right
<b>P</b>	<b>M</b>	Middle
<b>P</b>	<b>D</b>	Left and right
<b>P</b>	<b>G</b>	Left and middle
<b>P</b>	<b>F</b>	Right and middle
<b>P</b>	<b>K</b>	Left, middle and right

∅80mm cut out for: grommet (included) or dedicated media ports\*

													Width [mm]	Depth [mm]	Veneer
															Lacquered MDF: White (FI), Black (FG)
															Powder-coated base: White (FI), Black (FG)
															N Table top without inserted pads
															Basic price (GBP)
<b>W</b>	<b>N</b>	<b>R</b>	<b>R</b>	<b>N</b>	<b>2</b>	<b>3</b>	<b>N</b>	<b>N</b>	<b>E</b>	<b>N</b>	<b>N</b>	<b>X</b>	1800	900	<b>4394</b>
<b>W</b>	<b>N</b>	<b>R</b>	<b>R</b>	<b>N</b>	<b>2</b>	<b>8</b>	<b>N</b>	<b>N</b>	<b>E</b>	<b>N</b>	<b>N</b>	<b>X</b>	2000	1000	<b>4800</b>

<b>N</b>	Table top without inserted pads
<b>L</b>	Table top with inserted leather pad – leather in: black (S1) – surcharge 180 GBP

<b>X</b>	EU plug standard
<b>Y</b>	GB plug standard
<b>Z</b>	CH plug standard

control panel with display and memory function

\*∅80mm media ports available: Netbox Point, Pixel, miniBatt FR80 wireless charger  
All types of media ports to be ordered separately according to availability [matrix](#) and [price list](#)

# Desks

Rectangular table top  
Slab-end leg, for integration with sideboard

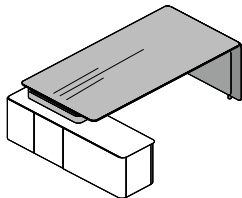

Left version on the drawing  
(to be assembled with left  
sideboard)

N	N	No cut outs for: cable outlets/media ports
P	L	Left
P	R	Right
E	L	Left
E	R	Right
E	M	Middle*

Rectangular cut out for metal cable outlet with brush 160×80mm (included)

Rectangular cut out for metal cable outlet with brush 240×100mm with access to media port Netbox M 4M (outlet as a part of media port)

												Width [mm]	Depth [mm]	Veneer
														Lacquered MDF: White (FI), Grey (FS), Black (FG)
														N Table top without inserted pads
														Basic price (GBP)
W	N	R	R	N	2	8	N	N	4	N	L	2013	1000	<b>3206</b>
W	N	R	R	N	2	9	N	N	4	N	L	2213		<b>3828</b>
												L	Left version	All types of media ports to be ordered separately according to availability <a href="#">matrix</a> and <a href="#">price list</a>
												R	Right version	
												N	Table top without drawer	* Not applicable to table top versions with inserted glass pad (G), or with inserted leather and glass pads (X)
												C	Table top with integrated drawer – surcharge 739 GBP	
												N	Table top without inserted pads	
												L	Table top with inserted leather pad – leather in: Black (S1) – surcharge 180 GBP	
												G	Table top with inserted glass pad – glass in: White (SI), Grey (SS), Black (SG) – surcharge 379 GBP	
												X	Table top with inserted leather and glass pads – leather in: Black (S1), glass in: White (SI), Grey (SS), Black (SG) – surcharge 556 GBP	

Available from - Merlin Industrial Products Ltd - 0800 0418 650 - [info@merlin-industrial.co.uk](mailto:info@merlin-industrial.co.uk)

## Sideboard for integration with desk

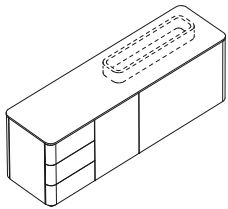
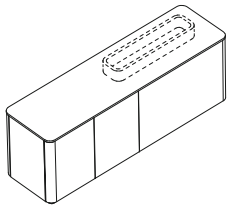

Left version on the drawing  
(to be assembled with left desk)

<b>N</b>	<b>N</b>	No cut out in bottom element
<b>P</b>	<b>L</b>	Left cut out in bottom element for cable management (applicable to right sideboard version only)
<b>P</b>	<b>R</b>	Right cut out in bottom element for cable management (applicable to left sideboard version only)

														Height [mm]	Width [mm]	Veneer	Veneer / Melamine faced chipboard (MFC)*	
																Lacquered MDF: White (FI), Grey (FS), Black (FG)		Basic price (GBP)
<b>W</b>	<b>N</b>	<b>R</b>	<b>S</b>	<b>B</b>	<b>F</b>	<b>V</b>	<b>1</b>	<b>6</b>	<b>N</b>	<b>N</b>	<b>L</b>	<b>N</b>	<b>Z</b>	4 hinged doors	577	1583	<b>3891</b>	<b>3196</b>
<b>W</b>	<b>N</b>	<b>R</b>	<b>S</b>	<b>B</b>	<b>F</b>	<b>D</b>	<b>1</b>	<b>6</b>	<b>N</b>	<b>N</b>	<b>L</b>	<b>N</b>	<b>Z</b>	3 hinged doors, pencil tray and 3 drawers			<b>4844</b>	<b>4404</b>

<b>N</b>	Without lock
<b>K</b>	With lock – surcharge 59 GBP
<b>L</b>	Left version
<b>R</b>	Right version

\*Top, front, sides, back and dividing wall made of veneer, internal elements: bottom part, upper part, shelves and drawers (if applicable) made of melamine faced chipboard (MFC) in slate colour (MS) only

Available from - Merlin Industrial Products Ltd - 0800 0418 650 - info@merlin-industrial.co.uk

# Sideboards

Sideboard for integration with desk

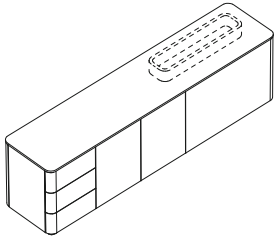
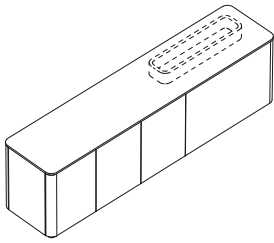

Left version on the drawing  
(to be assembled with left desk)

<b>N</b>	<b>N</b>	No cut out in bottom element
<b>P</b>	<b>L</b>	Left cut out in bottom element for cable management (applicable to right sideboard version only)
<b>P</b>	<b>R</b>	Right cut out in bottom element for cable management (applicable to left sideboard version only)

													Height [mm]	Width [mm]	Veneer	Veneer / Melamine faced chipboard (MFC)*		
													Lacquered MDF: White (FI), Grey (FS), Black (FG)		Basic price (GBP)			
<b>W</b>	<b>N</b>	<b>R</b>	<b>S</b>	<b>B</b>	<b>F</b>	<b>D</b>	<b>2</b>	<b>0</b>	<b>N</b>	<b>N</b>	<b>L</b>	<b>N</b>	<b>Z</b>	4 hinged doors, pencil tray and 3 drawers	557	1975	<b>6053</b>	<b>5220</b>

<b>N</b>	Without lock
<b>K</b>	With lock – surcharge 59 GBP
<b>L</b>	Left version
<b>R</b>	Right version

\*Top, front, sides, back and dividing wall made of veneer, internal elements: bottom part, upper part, shelves and drawers (if applicable) made of melamine faced chipboard (MFC) in slate colour (MS) only

Available from - Merlin Industrial Products Ltd - 0800 0418 650 - info@merlin-industrial.co.uk

# Conference tables

Free-standing  
Rectangular table top  
Column legs

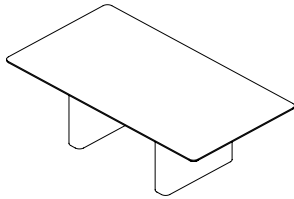

										Width [mm]	Depth [mm]	Veneer
												Lacquered MDF: White (FI), Grey (FS), Black (FG)
												Basic price (GBP)
W	N	R	K	A	N	N	2200	1200	<b>4240</b>			
					N	N	No cut outs for: media ports		All types of media ports to be ordered separately according to availability <a href="#">matrix</a> and <a href="#">price list</a>			
					E	L	Central left	Rectangular cut out for media port Netbox Line 5M				
					E	M	Central					
					E	D	Central left and central right					
					V	L	Central left	Ø103mm cut out for media port EVOLine Port				
					V	D	Central left and central right					

Modular  
External module  
Column leg

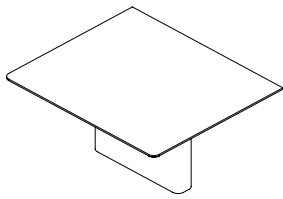

										Width [mm]	Depth [mm]	Veneer
												Lacquered MDF: White (FI), Grey (FS), Black (FG)
												Basic price (GBP)
W	N	R	K	B	N	N	1200	1400	<b>2754</b>			
					N	N	No cut outs for: media ports		All types of media ports to be ordered separately according to availability <a href="#">matrix</a> and <a href="#">price list</a>			
					E	M	Central rectangular cut out for media port Netbox Line 5M					
					V	M	Central Ø103mm cut out for media port EVOLine Port					

Internal module  
Column leg

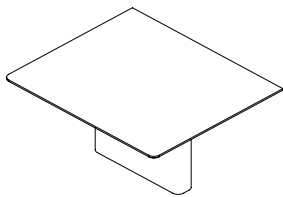

										Width [mm]	Depth [mm]	Veneer
												Lacquered MDF: White (FI), Grey (FS), Black (FG)
												Basic price (GBP)
W	N	R	K	C	N	N	1200	1400	<b>2652</b>			
					N	N	No cut outs for: media ports		All types of media ports to be ordered separately according to availability <a href="#">matrix</a> and <a href="#">price list</a>			
					E	M	Central rectangular cut out for media port Netbox Line 5M					
					V	M	Central Ø103mm cut out for media port EVOLine Port					

Available from - Merlin Industrial Products Ltd - 0800 0418 650 - [info@merlin-industrial.co.uk](mailto:info@merlin-industrial.co.uk)

# Panels

Modesty, front

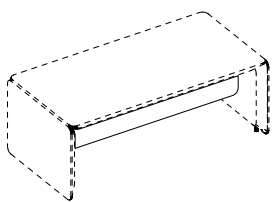

											For table top width [mm]	Panel width for free-standing desks [mm]	Panel width for desks integrated with sideboard [mm]	Veneer
														Basic price (GBP)
W	N	R	P	D	T	1	8	A	1		1800	1596		<b>302</b>
W	N	R	P	D	T	2	0	A	1		2000	1796	1418	<b>328</b>
W	N	R	P	D	T	2	2	A	1		2200	1996	1618	<b>363</b>

**1** For free-standing desks

**2** For desks integrated with sideboard

Modesty, front

For desks with T-legs

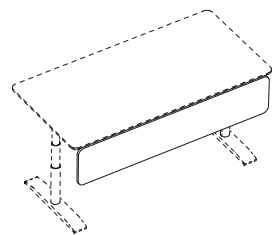

											For desk width [mm]	Panel width [mm]	Veneer
													Powder-coated brackets: Traffic white (BI), Jet black (CZ)
													Basic price (GBP)
W	N	R	P	D	T	1	8	A	1	E	1800	1716	<b>332</b>
W	N	R	P	D	T	2	0	A	1	E	2000	1916	<b>359</b>

Available from - Merlin Industrial Products Ltd - 0800 0418 650 - info@merlin-industrial.co.uk



## Mobile

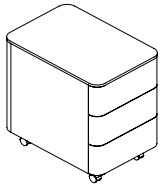

													Height [mm]	Width [mm]	Depth [mm]	Veneer / Melamine faced chipboard (MFC)*			
																Lacquered MDF: White (FI), Grey (FS), Black (FG)			
																Basic price (GBP)			
W	N	R	C	M	3	1	6	C	N	3 drawers and 1 black leather pencil tray inside			643	410	600	2251			
										N	Without lock						* All elements made of veneer, except for internal drawers parts made of melamine faced chipboard (MFC) in slate colour (MS) only		
										K	With lock – surcharge 55 GBP								

Available from - Merlin Industrial Products Ltd - 0800 0418 650 - info@merlin-industrial.co.uk

# Cabinets

Modular

Hinged door – external module

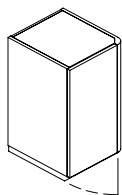

Right version on the drawing

											Without lock		With lock – surcharge 55 GBP		Veneer		Veneer / Melamine faced chipboard (MFC)*	
											Height [mm]**		Width [mm]	Depth [mm]	Lacquered MDF: White (FI), Grey (FS), Black (FG)			
											Basic price (GBP)							
W	N	R	S	W	0	4	2	Z	L	N	Z	2OH (788mm)	400	450	1181		870	
W	N	R	S	W	0	4	3	Z	L	N	Z	3OH (1140mm)			1355		1065	

Detailed information regarding possible arrangements – [see technical description](#)  
 \*Front and sides made of veneer, back and internal elements: bottom part, upper part and shelves made of melamine faced chipboard (MFC) in slate colour (MS) only  
 \*\*Total height with cabinet top (top to be ordered separately)

L Left version  
R Right version

Hinged door – external module

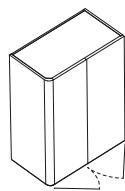

Left version on the drawing

											Without lock		With lock – surcharge 55 GBP		Veneer		Veneer / Melamine faced chipboard (MFC)*	
											Height [mm]**		Width [mm]	Depth [mm]	Lacquered MDF: White (FI), Grey (FS), Black (FG)			
											Basic price (GBP)							
W	N	R	S	W	0	8	2	Z	L	N	Z	2OH (788mm)	800	450	1809		1203	
W	N	R	S	W	0	8	3	Z	L	N	Z	3OH (1140mm)			2355		1718	

Detailed information regarding possible arrangements – [see technical description](#)  
 \*Front and sides made of veneer, back and internal elements: bottom part, upper part and shelves made of melamine faced chipboard (MFC) in slate colour (MS) only  
 \*\*Total height with cabinet top (top to be ordered separately)

L Left version  
R Right version

Available from - Merlin Industrial Products Ltd - 0800 0418 650 - [info@merlin-industrial.co.uk](mailto:info@merlin-industrial.co.uk)

## Hinged door – internal module

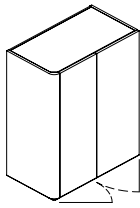

													<b>N</b>	Without lock			<b>Veneer</b>	<b>Veneer / Melamine faced chipboard (MFC)*</b>
													<b>K</b>	With lock – surcharge 55 GBP				
														<b>Height [mm]**</b>	<b>Width [mm]</b>	<b>Depth [mm]</b>	<b>Lacquered MDF: White (FI), Grey (FS), Black (FG)</b>	
																	<b>Basic price (GBP)</b>	
<b>W</b>	<b>N</b>	<b>R</b>	<b>S</b>	<b>W</b>	<b>0</b>	<b>8</b>	<b>2</b>	<b>S</b>	<b>N</b>	<b>N</b>	<b>Z</b>	2OH (788mm)	800	450	<b>1728</b>	<b>1130</b>		
<b>W</b>	<b>N</b>	<b>R</b>	<b>S</b>	<b>W</b>	<b>0</b>	<b>8</b>	<b>3</b>	<b>S</b>	<b>N</b>	<b>N</b>	<b>Z</b>	3OH (1140mm)			<b>2270</b>	<b>1371</b>		

Detailed information regarding possible arrangements – see [technical description](#)  
 \* Front and sides made of veneer, back and internal elements: bottom part, upper part and shelves made of melamine faced chipboard (MFC) in slate colour (MS) only  
 \*\* Total height with cabinet top (top to be ordered separately)

## Glass door – internal module

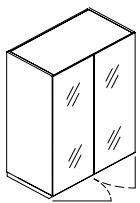

																<b>Veneer</b>	<b>Veneer / Melamine faced chipboard (MFC)*</b>	
														<b>Height [mm]**</b>	<b>Width [mm]</b>	<b>Depth [mm]</b>	<b>Lacquered MDF: White (FI), Grey (FS), Black (FG)</b>	
																	<b>Basic price (GBP)</b>	
<b>W</b>	<b>N</b>	<b>R</b>	<b>S</b>	<b>G</b>	<b>0</b>	<b>8</b>	<b>2</b>	<b>S</b>	<b>N</b>	<b>N</b>	<b>Z</b>	2OH (788mm)	800	450	<b>1814</b>	<b>1226</b>		
<b>W</b>	<b>N</b>	<b>R</b>	<b>S</b>	<b>G</b>	<b>0</b>	<b>8</b>	<b>3</b>	<b>S</b>	<b>N</b>	<b>N</b>	<b>Z</b>	3OH (1140mm)			<b>2420</b>	<b>1551</b>		

Detailed information regarding possible arrangements – see [technical description](#)  
 \* Front and sides made of veneer, back and internal elements: bottom part, upper part and shelves made of melamine faced chipboard (MFC) in slate colour (MS) only  
 \*\* Total height with cabinet top (top to be ordered separately)

# Cabinets

## Cabinet tops

For free-standing cabinet or cabinet arrangements

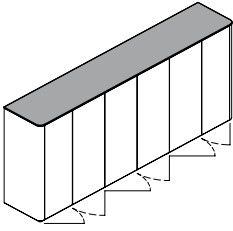

								Width [mm]	Veneer
									Basic price (GBP)
W	N	R	S	P	0	8	F	802	<b>197</b>
W	N	R	S	P	1	2	F	1202	<b>264</b>
W	N	R	S	P	1	6	F	1602	<b>333</b>
W	N	R	S	P	2	0	F	2002	<b>409</b>
W	N	R	S	P	2	4	F	2402	<b>478</b>

<b>F</b>	Both-sides rounded top
<b>L</b>	One-side rounded top – left
<b>R</b>	One-side rounded top – right
<b>S</b>	Rectangular top – middle

Available from - Merlin Industrial Products Ltd - 0800 0418 650 - [info@merlin-industrial.co.uk](mailto:info@merlin-industrial.co.uk)

## Mobile 2 hinged doors and 2 drawers

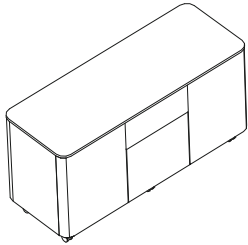

									<b>N</b>	<b>N</b>	No cut out																																		
									<b>P</b>	<b>L</b>	Left	Rectangular cut out for metal cable outlet with brush (included)																																	
									<b>P</b>	<b>R</b>	Right																																		
													<b>N</b>	Without lock																															
													<b>K</b>	With lock – surcharge 55 GBP																															
																	<b>Height [mm]</b>	<b>Width [mm]</b>	<b>Depth [mm]</b>																										
<b>W</b>	<b>N</b>	<b>R</b>	<b>S</b>	<b>B</b>	<b>M</b>	<b>H</b>	<b>1</b>	<b>2</b>	<b>N</b>	<b>N</b>	<b>N</b>	<b>N</b>	<b>Z</b>	638	1200	450																													
																						<b>Veneer</b>		<b>Veneer / Melamine faced chipboard (MFC)*</b>																					
																						<b>Lacquered MDF: White (FI), Grey (FS), Black (FG)</b>																							
																						<b>Basic price (GBP)</b>																							
																						<b>3404</b>		<b>2948</b>																					

## Mobile 2 hinged doors and 3 drawers

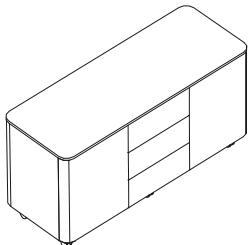

									<b>N</b>	<b>N</b>	No cut out																																		
									<b>P</b>	<b>L</b>	Left	Rectangular cut out for metal cable outlet with brush (included)																																	
									<b>P</b>	<b>R</b>	Right																																		
													<b>N</b>	Without lock																															
													<b>K</b>	With lock – surcharge 55 GBP																															
																<b>Height [mm]</b>	<b>Width [mm]</b>	<b>Depth [mm]</b>																											
<b>W</b>	<b>N</b>	<b>R</b>	<b>S</b>	<b>B</b>	<b>M</b>	<b>E</b>	<b>1</b>	<b>2</b>	<b>N</b>	<b>N</b>	<b>N</b>	<b>N</b>	<b>Z</b>	638	1200	450																													
																						<b>Veneer</b>		<b>Veneer / Melamine faced chipboard (MFC)*</b>																					
																						<b>Lacquered MDF: White (FI), Grey (FS), Black (FG)</b>																							
																						<b>Basic price (GBP)</b>																							
																						<b>3578</b>		<b>3120</b>																					